



Color Filters, A08070-A08074



A08931  
Color Filter Adapter



A08087 & A08086  
Input Lens Diffusers



Spot lens models, A08080, A08084, A08082



Polarizing cap, A08090, for spot lens, A08080

■ Manufactured in the USA.

# Filters, Diffusers & Spot Lenses

## Filters and Adapter

- Available in red, green, blue, yellow, and daylight. These Dichroic filters will not darken or alter spectral response over time, regardless of light intensity or duration. The daylight filter increases existing color temperature to approximately 3000 K when used with EKE, EJA, and DDL lamps at their rated voltages.
- Dichroic color filters reflect heat versus absorbing it, eliminating the need for a thermal expansion split.
- Filters fit on all our standard inputs. For our larger inputs and backlight inputs, use our color filter adapter, A08931, with the color filters.
- Clear anodized aluminum housing on the filters. Black anodized aluminum housing on the adapter.

## Diffusers

- Input lens diffuser, part number, A08086, broadens beam with minimal light loss and minimizes black hole phenomenon from fiber bundles.
- Opal diffuser option, part number, A08087, creates the most uniform light - almost flat illumination, but reduces output by 40%.
- Diffusers fit on all our standard inputs.

## Spot Lenses

- Used on distal ends of goosenecks and bundles to focus the light.

Part No.	First Spot Location	First Spot Diameter	Second Spot Location	Second Spot Diameter
A08080	40 mm	45 mm	80 mm	90 mm
A08082	40 mm	30 mm	80 mm	60 mm
A08084	40 mm	30 mm	80 mm	60 mm

- Polarizing cap, part number, A08090, is available for spot lens model, A08080, to eliminate glare and reflections. Five spare polarizing discs are included with the product.

Filters, Diffusers & Spot Lenses				
Part No.	Description			
Dichroic Color Filters & Adapter				
A08070	Blue	A08073	Red	A08931 Color Filter Adapter
A08071	Green	A08074	Daylight	
A08072	Yellow	A08075	UV Filter, Cut-off	
Diffusers				
A08086	Input lens diffuser			
A08087	Input opal diffuser			
Spot Lenses				
A08080	Spot lens for std. bundles except A08051.40 & A08051.60			
A08082	Small spot lens for std. bundles except A08051.40 & A08051.60			
A08084	Spot lens for models A08051.40 & A08051.60			
Polarizing Cap (for A08080)				
A08090	Polarizing cap for A08080			

FIBER OPTIC ACCESSORIES



# Filters, Diffusers & Spot Lenses

Dimensions in ( ) are in mm

**A08070 - A08074**  
Dichroic Color Filters

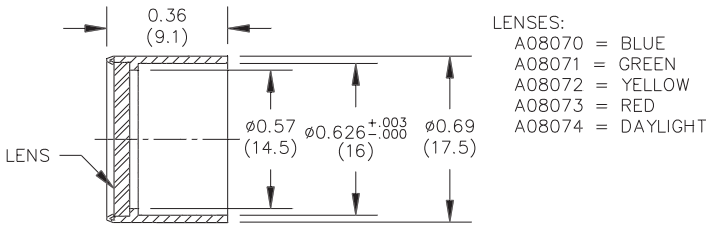

**A08086**  
Input Lens Diffuser

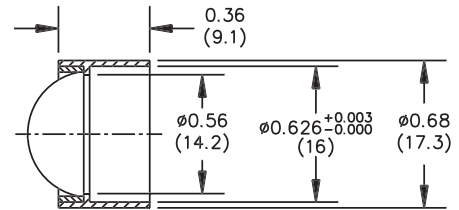

**A08931**  
Color Filter Adapter

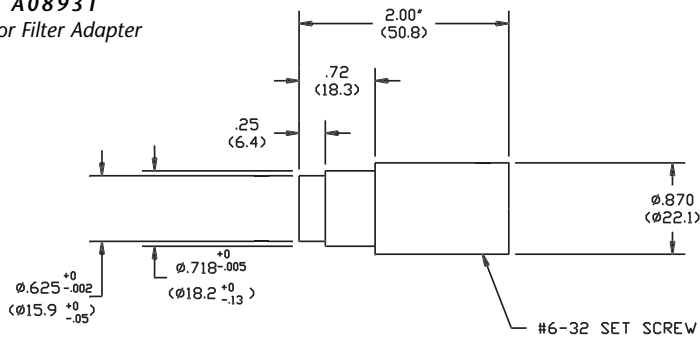

**A08087**  
Input Opal Diffuser

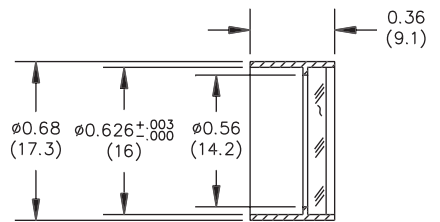

**A08080**  
Spot Lens

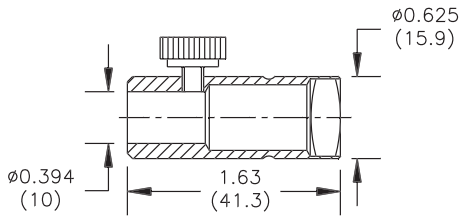

**A08082**  
Small Spot Lens

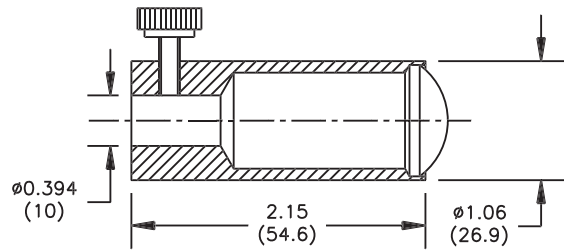

**A08084**  
Spot Lens

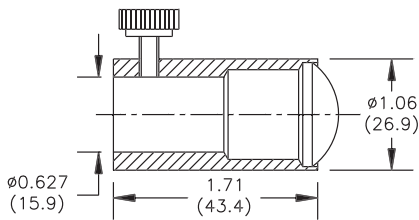

**A08090**  
Polarizing Cap

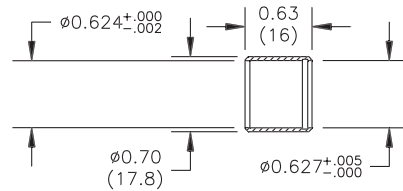

TECHNICAL SPECIFICATIONS

Fiber Optics

SCHOTT North America, Inc.

62 Columbus Street

Auburn, NY 13021-3137

USA

Phone: +1315/255-2791

Fax: +1315/255-2695

E-mail: [fiberoptics.auburn@us.schott.com](mailto:fiberoptics.auburn@us.schott.com)

[www.us.schott.com/fiberoptics](http://www.us.schott.com/fiberoptics)

**SCHOTT**